

# LUNARDA

*design | Alessandro Lenarda*



The moonlight  
Crescent moon – falling moon.  
Rotate your lamp according to your mood ...

*La luce della Luna  
Luna calante – luna crescente.  
Ruota la tua lampada secondo il tuo umore...*

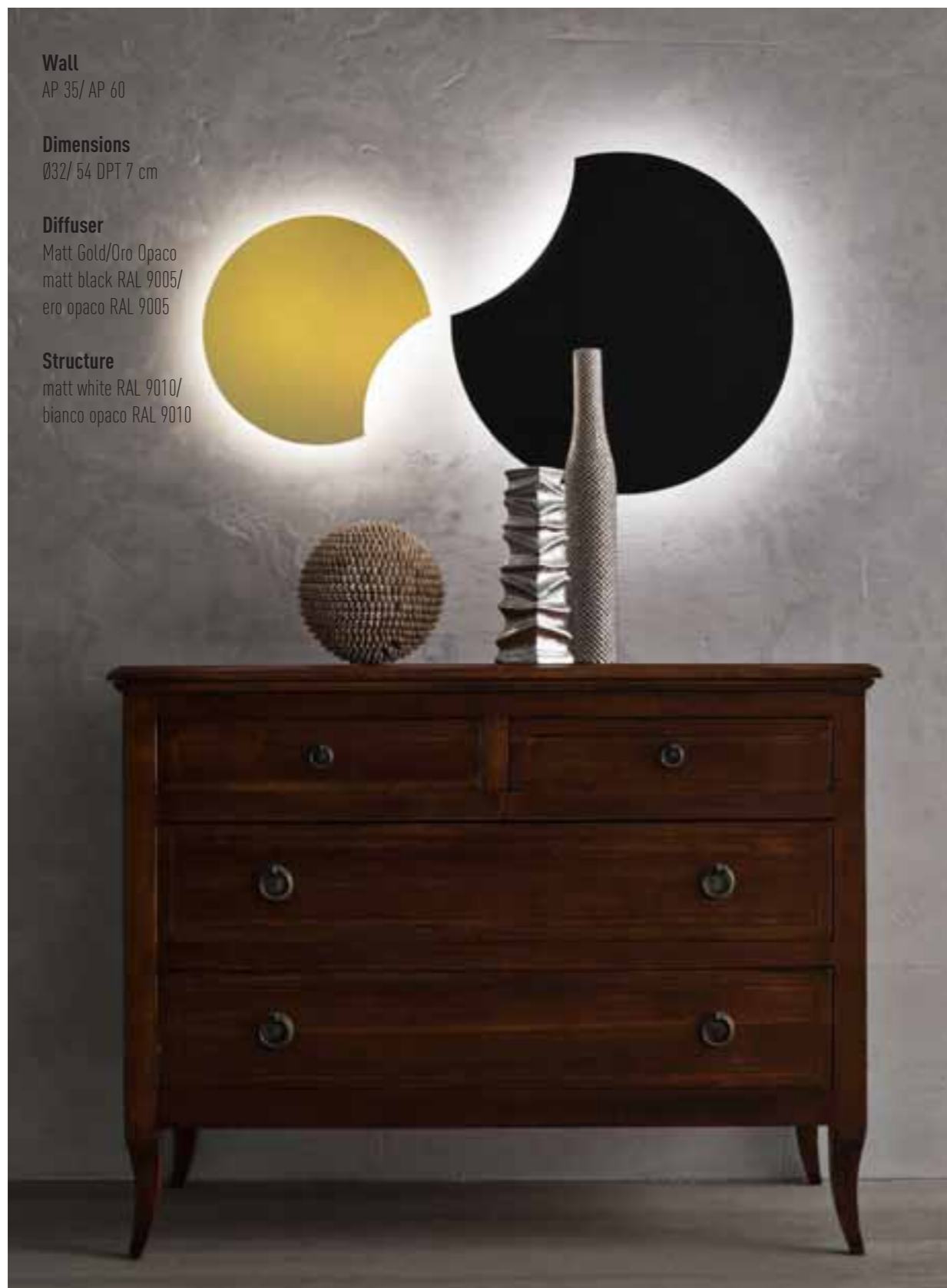

**Wall**  
AP 35/ AP 60

**Dimensions**  
Ø32/ 54 DPT 7 cm

**Diffuser**  
Matt Gold/Oro Opaco  
matt black RAL 9005/  
oro opaco RAL 9005

**Structure**  
matt white RAL 9010/  
bianco opaco RAL 9010



**Wall**  
AP 35

**Dimensions**  
Ø32 DPT 7 cm

**Diffuser**  
matt white RAL 9010/  
bianco opaco RAL 9010

**Structure**  
matt white RAL 9010/  
bianco opaco RAL 9010

Turned metal lamp, 3D laser cut.  
It is formed by a circular element, rotates 360° and it is available  
in 2 sizes: diam. 35, 60 cm. The result is that of a luminous crown  
with a pleasant directable – non indirect light that illuminates the  
wall and is free of glaring effects.  
Depth ADA.

*Lampada tornita in metallo, tagliata a laser 3D. È  
formata da un elemento circolare, ruota a 360° ed è  
disponibile in 2 misure diam. 35, 60 cm.  
Il risultato è quello di una corona luminosa con una  
gradevole luce è direzionabile - non indiretta che  
illumina la parete ed è priva di effetti abbaglianti.  
Profondità ADA*

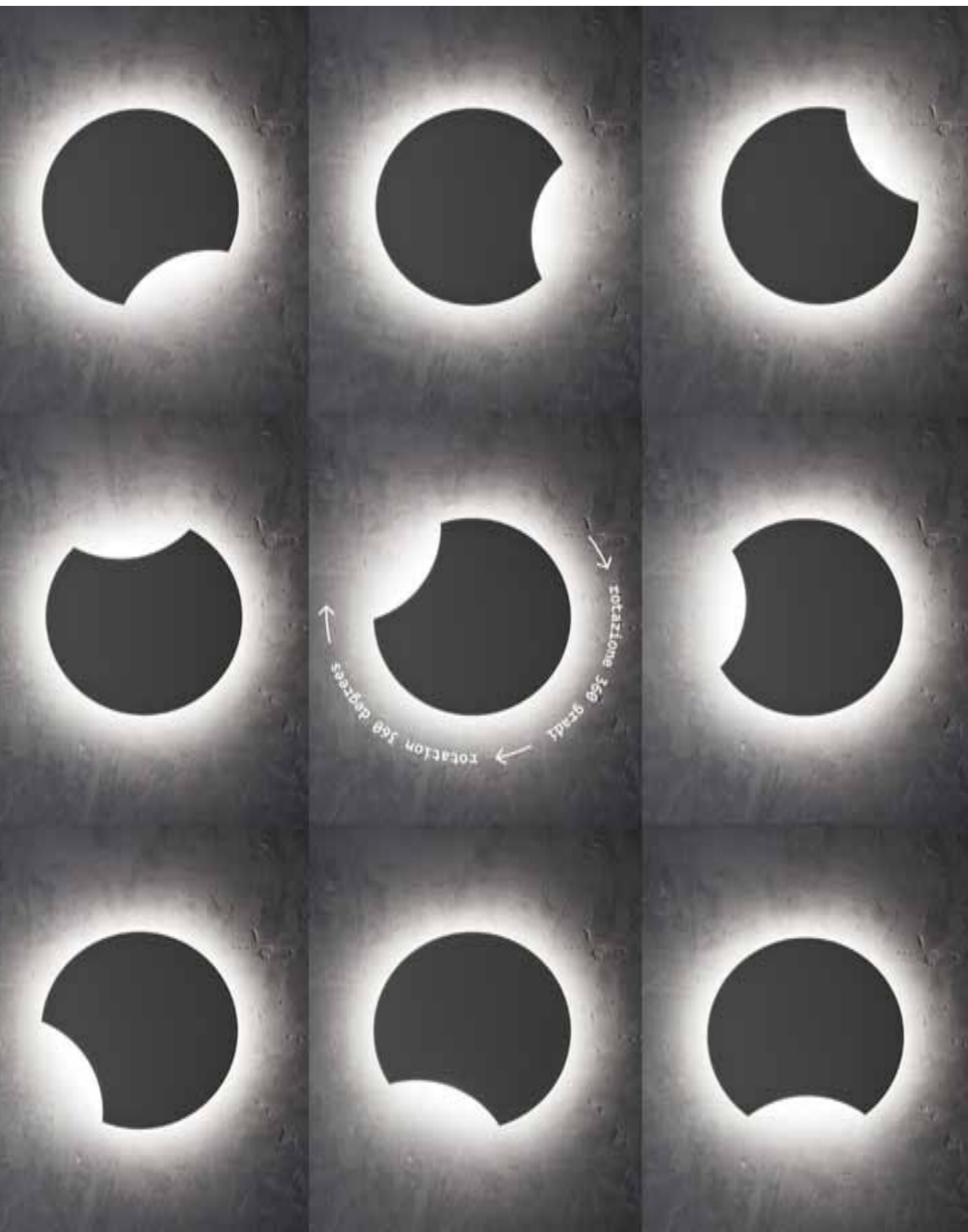

# LUNARDA

collection

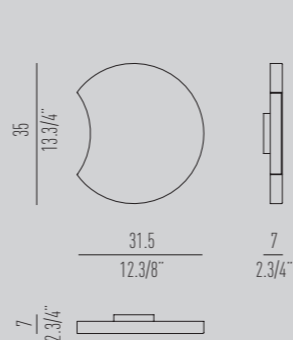

**APPLIQUE 35**



Lamp / 3 X G9 SUITABLE FOR LED LAMPS

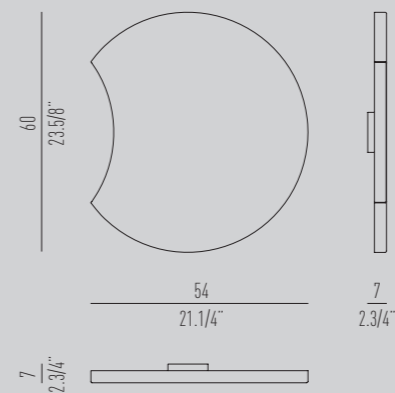

**APPLIQUE 60**



Lamp / 6 X G9 SUITABLE FOR LED LAMPS

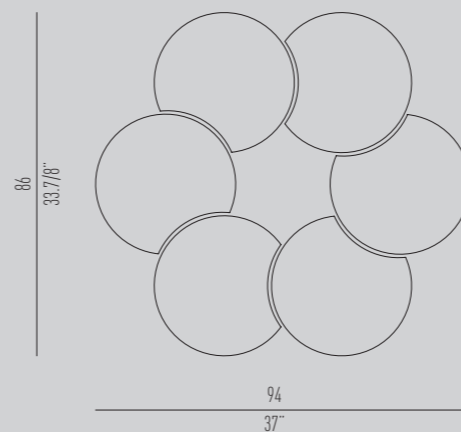

**APPLIQUE COMPO 01**

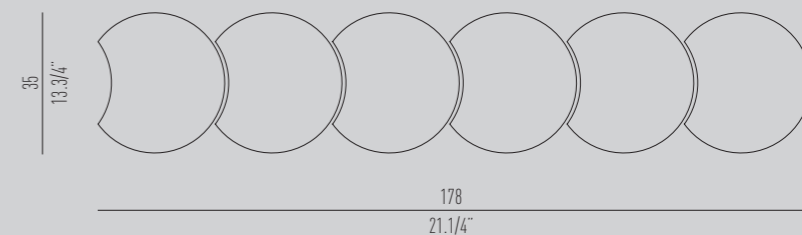

**APPLIQUE COMPO 02**

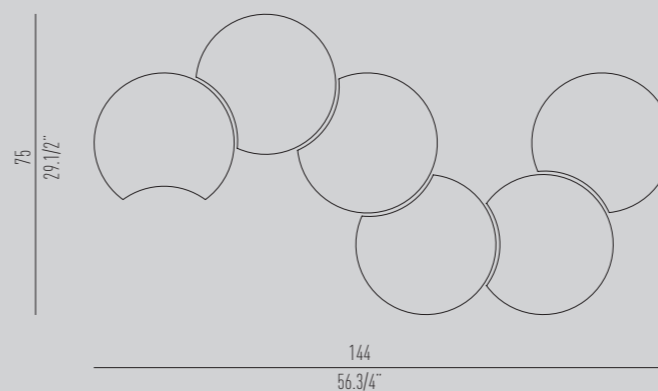

**APPLIQUE COMPO 03**



**COLORS**

-  white 9010 / bianco 9010
-  matt gold / oro opaco
-  black 9005 / nero 9005